

HUBER+SUHNER® PLANAR ANTENNA FOR WIRELESS COMMUNICATION

SPA 5600/65/12/0/V



Technical Data

Electrical Properties

Frequency range	5150 – 5875 MHz
Impedance	50 Ω
VSWR	1.5
Polarization	linear, vertical
Gain	11.5 dBi
3 dB beamwidth horizontal	65°
3 dB beamwidth vertical	35°
Downtilt	0°
Front to back ratio	18 dB
Max. power	80 W (CW) at 50°C

Mechanical Properties

Dimensions	101 x 80 x 20 mm (3.97" x 3.15" x 0.79")
Weight	0.13 kg (0.29 lbs.)
Radome material	ASA
Radome color	RAL 7035 (light-grey)
Operating temperature range	- 40°C to + 80°C
Storage temperature range	- 40°C to + 80°C
Windload	15 N at 160km/h (100mph)

Available Types

Article no.

1356.19.0002	23041806	SMA female
1356.26.0002	23041809	TNC female

Mounting Hardware

Wall and mast mounting bracket (1 metal band) included, mast diameter 40-60 mm (1.57" – 2.36")

Radiation Pattern

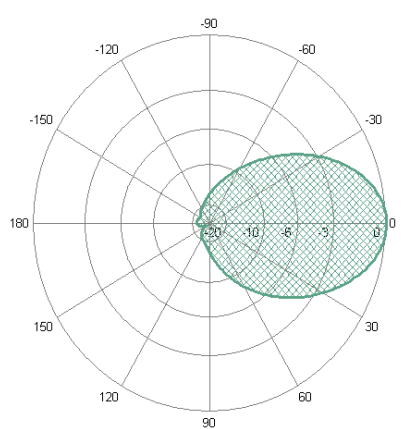

horizontal

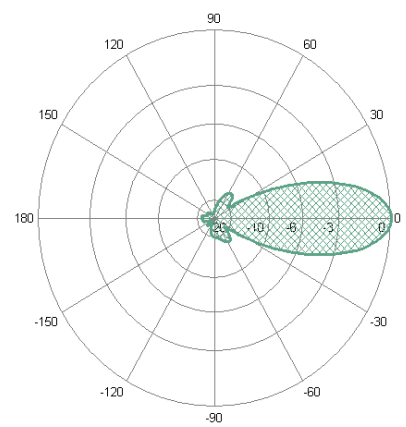

vertical

HUBER+SUHNER® PLANAR ANTENNA FOR WIRELESS COMMUNICATION

SPA 5600/65/12/0/V

Dimensions (mm)

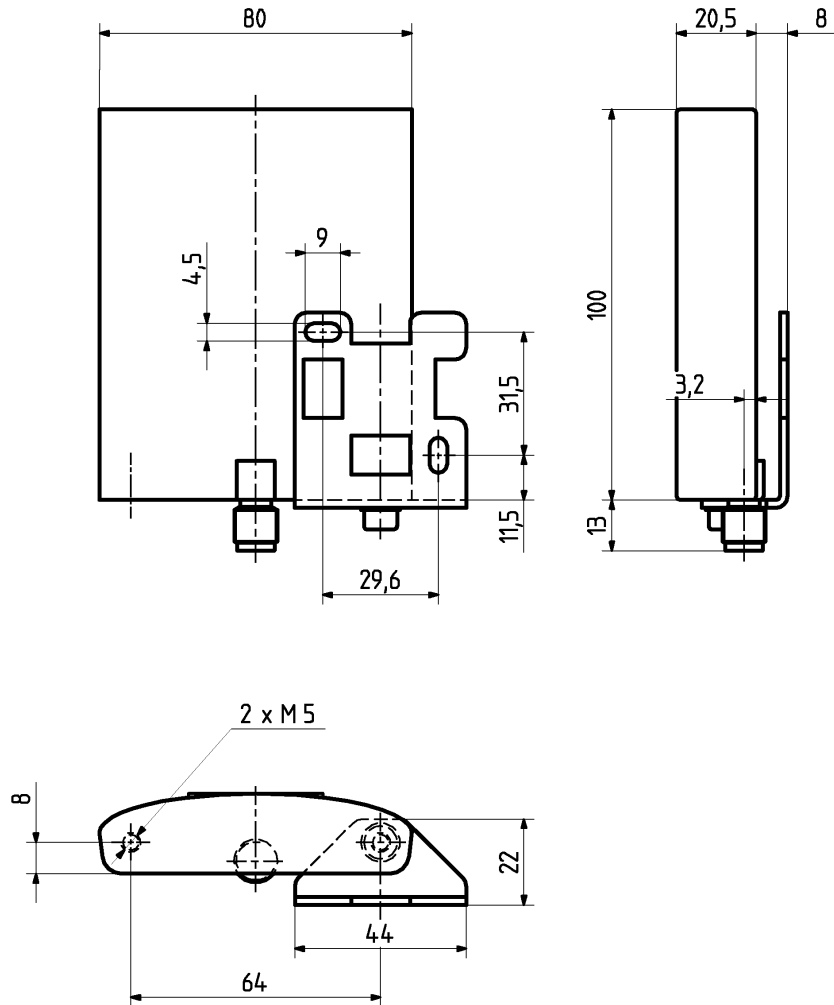

Mounting and security instructions see HUBER+SUHNER document number 01.02.0777.
The document can be ordered at HUBER+SUHNER AG, Switzerland.

HUBER+SUHNER group is certified according to ISO 9001 and ISO 14001.

WAIVER!
While the information contained has been carefully compiled to the best of our present knowledge, it is not intended as representation or warranty of any kind on our part regarding the fitness of the products concerned for any particular use or purpose and neither shall any statement contained herein be construed as a recommendation to infringe any industrial property rights or as a license to use any such rights. The fitness of each product for any particular purpose must be checked beforehand with our specialists.



HUBER+SUHNER AG
Wired Solutions + Networks
Communication + Power Networks
CH-9100 Herisau, Switzerland
Tel.: +41 (0)71 353 41 11
Fax: +41 (0)71 353 47 51
www.hubersuhner.com

Document no.: 01.02.0980
Issue no.: 1
Supersedes: 10.2003

Uncontrolled Copy
Issued/Checked/Released: 4159/4174/10.2003
Last amended: 4159

